

370-2042

SIFONE DI SCARICO TELESCOPICO A BOTTIGLIA BOB

Sifone di scarico telescopico a bottiglia, tondo. Materiale ottone. Canotto regolabile 120/320 mm.

 370-2042-07	 1"1/4 Cromo	 1
---	--	---



370-2052

SIFONE DI SCARICO QUADRO TED

Sifone di scarico telescopico, quadro. Materiale ottone. Canotto regolabile 120/320 mm.

 370-2052-07	 1"1/4 Cromo	 1
---	--	---



370-280



DISOTTURATORE STURATUBI CON MANOVELLA

Sturalavandini azionabile con la manovella.

 370-280	 mt. 3,50 x 6,7 mm	 50
370-280-05	mt. 5,00 x 6,7 mm	50
370-280-07	mt. 7,00 x 6,7 mm	1
370-280-10	mt. 10,00 x 6,7 mm	50





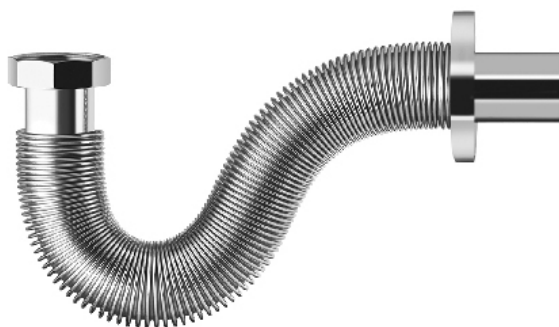

370-2803**STURA PER TURCA CON MANICO IN LEGNO**

 370-2803	 Diam. 120	 1
--	--	---



**370-300****TUBO DI SCARICO BPS FLESSIBILE-ESTENSIBILE
IN ACCIAIO INOX**

In acciaio INOX AISI 304. Estensibile da 300 a 450 mm. Ghiera in ottone cromato da 1"1/4. Guarnizione con bordo di sicurezza in NBR. Rosone in acciaio. Portata: passaggio totale. Applicazione: lavabo, bidet, lavello. Tipo di installazione esterna. Temperatura min. -30°C. Temperatura max. +90°C. Innesto tubo: D. 32 mm. Finitura acciaio lucido.

 370-300-07	 1"1/4 x 32	 1
--	---	---

**370-V890****SIFONE DI SCARICO TONDO MODERNO**

Materiale: Tutto in ottone. Tubo orizzontale: L=Max.290 mm. Tubo verticale: L=Max.130 mm. Utilizzo: Adatto per lavabo 1"1/4. Tappo di ispezione: Presente sul fondo. Attacco sifone al lavabo: 1"1/4. Uscita: Tubo D.32 mm con rosetta.

 370-V890-07	 1" 1/4 Cromo	 1
---	---	---



370-X00**SIFONE AD S SENZA PILETTA CON CANNA DA
CM.25 MODELLO LUX**

Categoria LUX

Modello	Dimensione	Quantità
370-X00-06	1"	1
370-X00-07	1"1/4	1

370-X01**SIFONE AD S A COLONNA SENZA PILETTA CON
CANNA DA CM.25 MODELLO LUX**

Categoria LUX

Modello	Dimensione	Quantità
370-X01-06	1"	1
370-X01-07	1"1/4	1

370-X02**SIFONE A BOTTIGLIA SENZA PILETTA CON
CANNA DA CM.25 MODELLO LUX**



Categoria LUX

Modello	Dimensione	Quantità
370-X02-06	1"	1
370-X02-07	1"1/4	1

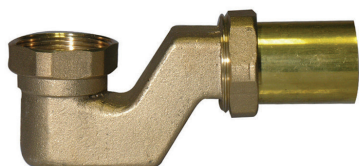

370-230**SIFONE PER COLONNA VASCA IN OTTONE**

Sifone ribassato in ottone per colonna vasca.

 370-230-08	 1"1/2	 1
--	--	---



**370-238****PILETTA CLICK-CLACK CON TROPPO PIENO**

Piletta clik-clak per lavabo-bidet da 1" 1/4 per spessori da 13 a 46 mm con troppo pieno; per igienici dotati di foro troppo pieno. Cromo.

 370-238-07	 1" 1/4	 1
--	---	---

**370-239****PILETTA LAVABO CLICK-CLACK CON VITE LUX**



Piletta click-clack per lavabo, con tappo coprente in ottone pesante lusso, fissaggio con vite per spessori igienici universali in ceramica e vetro da 0 a 70 mm con e senza foro troppo pieno. Dotata di regolazione chiusura tappo.

 370-239	 1" 1/4	 1
---	---	---



370-2390**PILETTA LAVABO CLICK-CLACK LEM**

Piletta lavabo click-clack. Idonea per lavabi con e senza troppo pieno.

 370-2390-NE	 Nera	 1
---	---	---



370-2401**PILETTA LAVABO CLICK-CLACK TAPPO TONDO
CON TROPPO PIENO LUX**

Piletta Click-Clack in ottone cromato con troppo pieno, tappo coprente tondo per lavabo spessore minimo 30mm - max 45mm. Dotata di tappo estraibile.

 370-2401	 1" 1/4	 1
--	---	---



370-2402**PILETTA LAVABO CLICK-CLACK TAPPO QUADRO
CON TROPPO PIENO**

Piletta Click-Clack in ottone cromato con troppo pieno, tappo coprente quadro per lavabo spessore minimo 30mm - max 45mm. Dotata di tappo estraibile.



 370-2402	 1" 1/4	 1
--	---	---



370-2403

PILETTA LAVABO CON TAPPO SEMPRE APERTO TONDO LUX

Piletta in ottone cromato con troppo pieno, tappo coprente tondo sempre aperto per lavabo spessore minimo 30mm - max 45mm. Idonea per rubinetteria elettronica o temporizzata.

 370-2403	 1" 1/4	 1
--	---	---

**370-2404**

PILETTA LAVABO CLICK-CLACK TAPPO QUADRO LUX

Piletta click-clack d'arredo con tappo quadrato coprente in ottone cromato lux. Fissaggio con vite per installazioni universali per ceramica e vetro con spessori da 0 a 60mm Igienici con e senza troppo pieno.

 370-2404	 1" 1/4	 1
--	---	---

**370-2406**

PILETTA LAVABO CLICK-CLACK TAPPO TONDO IN CERAMICA BIANCO

Piletta click-clack d'arredo con tappo tondo coprente in ceramica bianca. Fissaggio con vite per installazioni universali.

 370-2406	 1" 1/4	 1
--	---	---



370-241

PILETTA BIDET-LAVABO CON TROPPO PIENO SENZA CODOLO

Piletta con tappo in gomma. Lunghezza corpo 70mm.

370-241	1"	5

**370-24110**

PILETTA CLICK-CLACK LAVABO "FANCY" SENZA TROPPO PIENO

Piletta lavabo click-clack 1"1/4, con tappo in ceramica tondo.

370-24110-AR	Arancio	1
370-24110-BG	Beige	1
370-24110-BI	Bianco	1
370-24110-GC	Grigio Cemento	1
370-24110-GL	Giallo	1
370-24110-NE	Nero	1
370-24110-RC	Rosso Corallo	1
370-24110-RM	Rosso Mattone	1
370-24110-SB	Sabbia	1
370-24110-SL	Salmone	1
370-24110-VF	Verde Foresta	1
370-24110-VM	Verde Mela	1

**370-24111**

PILETTA CLICK-CLACK LAVABO "FANCY" CON TROPPO PIENO

Piletta lavabo click-clack 1"1/4, con tappo in ceramica tondo.

370-24111-AR	Arancio	1
370-24111-BG	Beige	1
370-24111-BI	Bianco	1
370-24111-GC	Grigio Cemento	1
370-24111-GL	Giallo	1
370-24111-NE	Nero	1
370-24111-RC	Rosso Corallo	1
370-24111-RM	Rosso Mattone	1
370-24111-SB	Sabbia	1
370-24111-SL	Salmone	1
370-24111-VF	Verde Foresta	1
370-24111-VM	Verde Mela	1



pilette in ottone

370-24120

PILETTA CLICK-CLACK LAVABO "FANCY MATT" SENZA TROPPO PIENO

Piletta lavabo click-clack 1"1/4, con tappo in ceramica tondo.



Icona	Modello	Descrizione	Quantità
	370-24120-BI	Bianco Opaco	1
	370-24120-NE	Nero Opaco	1

370-24121

PILETTA CLICK-CLACK LAVABO "FANCY MATT" CON TROPPO PIENO

Piletta lavabo click-clack 1"1/4, con tappo in ceramica tondo.



Icona	Modello	Descrizione	Quantità
	370-24121-BI	Bianco Opaco	1
	370-24121-NE	Nero Opaco	1

370-247

VALVOLA CATANIA

Valvola a sifone per lavabo vasche, lavatoi. Sistema a scarico Catania.

Icona	Modello	Descrizione	Quantità
	370-247-30	Diam. 30	20
	370-247-35	Diam. 35	20
	370-247-40	Diam. 40	15



370-H120**GATTINARA PER LAVABO**

In acciaio AISI 304.



		
370-H120-6538	D. 65 per tappo 38,5/40	1
370-H120-7045	D. 70 per tappo 45,5/47	1
370-H120-7050	D. 70 per tappo 50,5/52	1
370-H120-8050	D. 80 per tappo 50,5/52	1

**370-H121****GATTINARA 3"1/2 PER PILETTA LAVELLO**

In acciaio AISI.





		
370-H121-29	D. 114 - H. 29	1
370-H121-36	D. 114 - H. 36	1

**370-H123****GRIGLIA TROPPOPIENO PORTA TAPPO**

In acciaio AISI 304. Diam. 65 - Tappo 45.5-47.



		
370-H123-65	D. 65	1



370-H124**GRIGLIA TROPPOPIENO D. 35**

In acciaio AISI 304.

 370-H124-35	 D. 35	 1
---	--	---







**370-M3093****PILETTA CLICK-CLACK SENZA TROPPO PIENO**

Piletta click-clack in ottone cromato per lavabo e bidet con spessore da 13 a 46mm senza troppo pieno. Tappo tondo piccolo, non coprente.

 370-M3093	 1" 1/4	 5
---	---	---

**370-X40****PILETTA LAVABO S.T.P. SENZA DADO E CODOLO
MODELLO LUX**



Categoria LUX

 370-X40	 1"	 5
 370-X40-07	 1"1/4	 5





370-X41
**PILETTA BIDET-LAVABO CON TROPPO PIENO
SENZA CODOLO MODELLO LUX**

Categoria Lux.



 370-X41-07	 1" 1/4	 5
--	---	---

**370-X42**
**PILETTA GATTINARA SENZA CODOLO MODELLO
LUX**

Categoria LUX

 370-X42	 1"1/4	 20
---	--	--

**370-X421**
PILETTA GATTINARA SENZA CODOLO

 370-X421	 Per foro diam. 45 mm - 1"1/4	 1
--	---	---





370-X423**PILETTA SIMPLEX DA 1"1/2 D.80**

Con tappo ad anello.

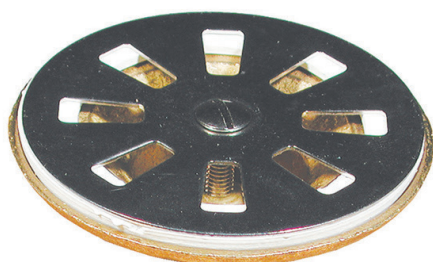
		
370-X423-08	1"1/2 Diam. 80	1



**370-X43****PILETTA CON GRIGLIA SENZA CODOLO
MODELLO LUX**

Categoria LUX

		
370-X43	1"1/4	15
370-X43-08	1"1/2	15

**370-X44****PILETTA PIATTO DOCCIA SCATOLATA SENZA
CODOLO MODELLO LUX**

Categoria LUX



		
370-X44	1"1/4	2



370-X441

TUBETTO E GRIGLIA PER PILETTA PIATTO DOCCIA SCATOLATA

Tubetto e griglia con OR, per piletta piatto doccia scatolata modello LUX ns.
articolo 370-X44.



 370-X441	 -	 1
--	--	---

**370-X45**

PILETTA SIFOIDE PIATTO DOCCIA CERAMICA TIPO LUX





Categoria LUX. Piletta sifoide per piatto doccia in ceramica, senza raccordo.

 370-X45	 1"1/4	 5
---	--	---

**370-X451**

CESTELLO PER PILETTA SIFOIDE



Cestello per piletta sifoide nostro art. 370-X45.

 370-X451	 Diam. 60/40 -H. 20 mm	 1
--	--	---





370-X46**PILETTONE SIFOIDE SENZA CODOLO -
MODELLO LUX**

Categoria LUX

 370-X46	 1" 1/4	 2
---	---	---



**370-260****COLONNA SCARICO VASCA IN OTTONE
MODELLO A SEDERE**

Tenuta pressochè illimitata perchè il meccanismo non è a contatto con l'acqua. Lunghezza della colonna distesa cm.64. Realizzata completamente in rame e ottone. Tubo di rame spiralato diam.30. Attacco del sifone filettato 1"1/2 universale.

 370-260	 -	 20
---	--	--

**370-261****COLONNA SCARICO VASCA IN OTTONE SENZA
DADO E CODOLO**

Tenuta pressochè illimitata perchè il meccanismo non è a contatto con l'acqua. Lunghezza della colonna distesa cm. 56. Realizzata completamente in rame e ottone. Tubo di rame spiralato diam.30. Attacco del sifone filettato 1"1/2 universale.

 370-261	 -	 20
---	--	--





370-263**COLONNA SCARICO VASCA CON EROGATORE IN PPR**

Colonna per scarico vasca in polipropilene con tubo di troppo pieno flessibile ed erogazione dal troppo pieno con bocca in abs.



 370-263	 1" 1/2	 1
---	---	---

**370-264****COLONNA SCARICO VASCA IN OTTONE SIMPLY**

Finitura cromo. Materiale corpo colonna in ottone. Adatto per vasca da bagno standard. Lunghezza scarico vasca max 550 mm.

 370-264	 1"1/2	 25
---	--	--

**370-315****MANIGLIA DI RICAMBIO 4 GOLE PER COLONNA VASCA**

 370-315	 Cromo	 1
---	--	---





colonne di scarico vasca

370-W261



COLONNA SCARICO VASCA IN OTTONE SENZA DADO E CODOLO MOD. IMPEX

Prodotto di importazione.

 370-W261	 -	 20
--	---	--



370-Z111



TAPPO SALTERELLO DI RICAMBIO PER COLONNA VASCA



 370-Z111	 <i>Diam. 43 mm</i>	 1
--	--	---



370-Z113

TAPPO SALTERELLO IN OTTONE CROMATO PER COLONNA VASCA



 370-Z113	 <i>Diam. 70</i>	 1
--	---	---



361-SIL



SIFONE LAVATRICE INCASSO CON PLACCA BIANCA

Sifone ad incasso per lavatrice in PVC a saldare o a innestare a guarnizione.
Materiale PEHD, colore nero, piastra e accessori in plastica colore bianco.

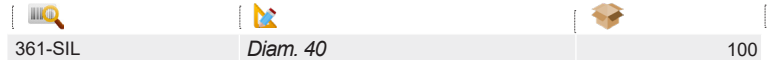

361-SIL

Diam. 40

100



DIANHYDRO

361-SILINOX

SIFONE LAVATRICE AD INCASSO CON PLACCA INOX



Sifone ad incasso per lavatrice in PVC a saldare o a innestare a guarnizione.
Materiale PEHD. Piastra acciaio Inox.

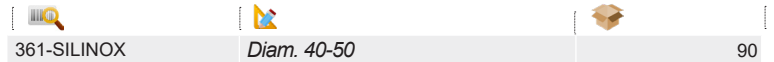

361-SILINOX

Diam. 40-50

90



DIANHYDRO

361-SLL

SIFONE LAVATRICE / LAVASTOVIGLIE AD INCASSO C/ PLACCA BIANCA



Sifone ad incasso per lavatrice e lavastoviglie in PVC ad incollaggio diretto con
le tubazioni. Colore grigio. Dado e portagomma bianchi, con piastra in plastica
ABS bianca.

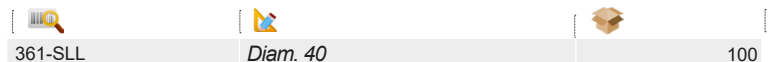

361-SLL



Diam. 40

100





DIANHYDRO

371-290**PIASTRA SIFONE LAVATRICE**

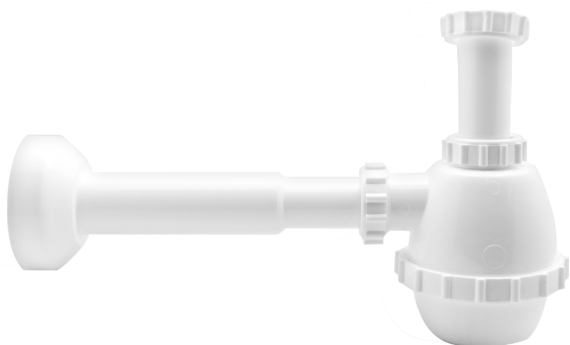
		
371-290-150	85 x 150 foro Diam. 34	1
371-290-160	160 x 110 foro Diam. 34	1



**DIANHYDRO****371-300****SIFONE PVC 1 VIA S / PILETTA PER PORCELLANA CON CANOTTO**

Sifone dotato di un canotto speciale che collega il sifone con ingresso diam. 32, allo scarico a muro con uscita diam. 40. Il corpo sifone rimane solito, con ingressi da diam. 32.

		
371-300	1"1/4	40

**DIANHYDRO****371-301****SIFONE PVC 2 VIE S / PILETTA PER PORCELLANA CON CANOTTO**

Sifone dotato di un canotto speciale che collega il sifone con ingresso diam. 32, allo scarico a muro con uscita diam. 40. Il corpo sifone rimane solito, con ingressi da diam. 32.

		
371-301	1"1/4	30

**DIANHYDRO**

371-302



SIFONE PVC 1 VIA C / PILETTA PER PORCELLANA CON CANOTTO

Sifone dotato di un canotto speciale che collega il sifone con ingresso diam. 32, allo scarico a muro con uscita diam. 40. Il corpo sifone rimane solito, con ingressi da diam. 32.

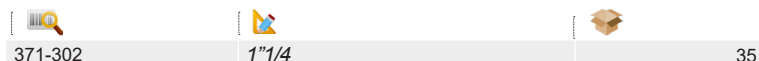

371-302

1"1/4

35



DIANHYDRO

371-303



SIFONE PVC 2 VIE C / PILETTA PER PORCELLANA CON CANOTTO

Sifone dotato di un canotto speciale che collega il sifone con ingresso diam. 32, allo scarico a muro con uscita diam. 40. Il corpo sifone rimane solito, con ingressi da diam. 32.

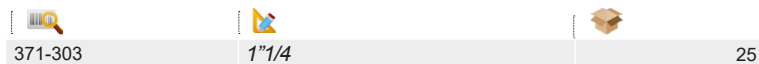

371-303

1"1/4

25



DIANHYDRO

371-310



SIFONE PVC 1 VIA S / PILETTA PER INOX

Nuovo corpo sifone con scarichi interamente del diametro 40 come da nuove normative europee.



371-310

1"1/2 Diam. 40

35



DIANHYDRO

371-311

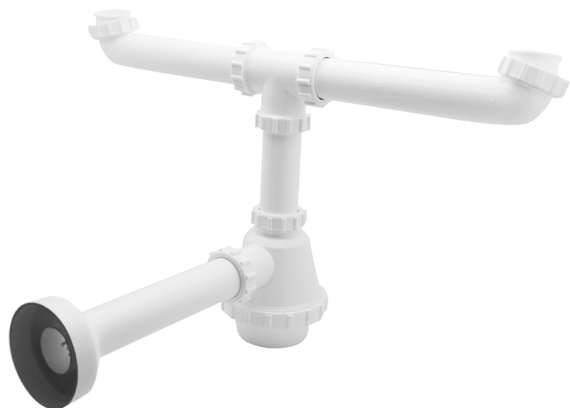

SIFONE PVC 2 VIE S / PILETTA PER INOX

Nuovo corpo sifone con scarichi interamente del diametro 40 come da nuove normative europee.

 371-311	 1"1/2 Diam. 40	 20
---	---	--





DIANHYDRO

371-3120



SIFONE "EURO" PER LAVELLI 1 VIA

 371-3120	 1" 1/2 Diam.40	 40
--	---	--



DIANHYDRO

371-3121



SIFONE PER LAVELLO 1 VIA CON ATTACCO LAVATRICE

 371-3121	 1" 1/2 Diam.40	 40
--	---	--



DIANHYDRO

371-3122

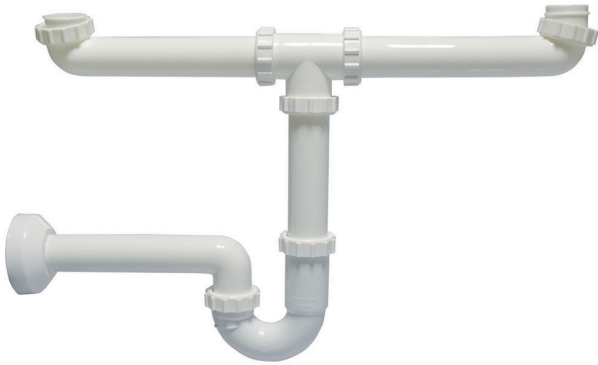

SIFONE "EURO" PER LAVELLI A 2 VIE



DIANHYDRO

371-3123

SIFONE PER LAVELLI A 2 VIE CON ATTACCO LAVATRICE

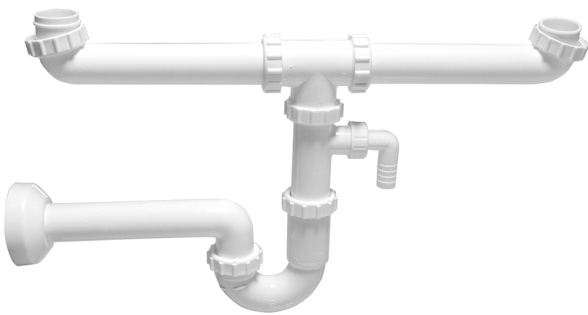

DIANHYDRO

371-320

**SIFONE PVC 1 VIA C / PILETTA E SCARICO
LAVATRICE C/CANOTTO**



Sifone dotato di un canotto speciale che collega il sifone con ingresso diam. 32, allo scarico a muro con uscita diam. 40. Il corpo sifone rimane solito, con ingressi da diam. 32.

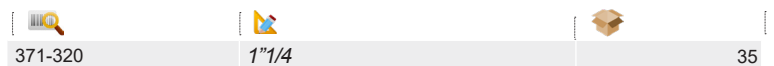

DIANHYDRO

371-321

SIFONE PVC 2 VIE C / PILETTA E SCARICO LAVATRICE C/CANOTTO

Sifone dotato di un canotto speciale che collega il sifone con ingresso diam. 32, allo scarico a muro con uscita diam. 40. Il corpo sifone rimane solito, con ingressi da diam. 32.

 371-321	 1"1/4	 20
---	--	--

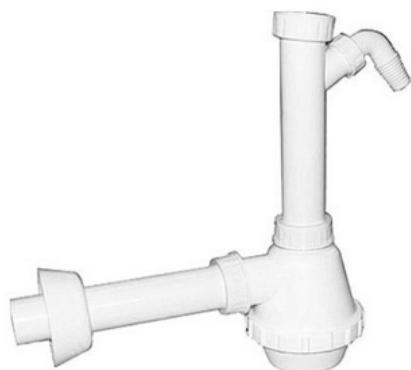
371-322

SIFONE PVC 1 VIA S / PILETTA E SCARICO LAVATRICE

Nuovo corpo sifone con scarichi interamente del diametro 40 come da nuove normative europee.

 371-322	 1"1/2 Diam. 40	 30
---	---	--

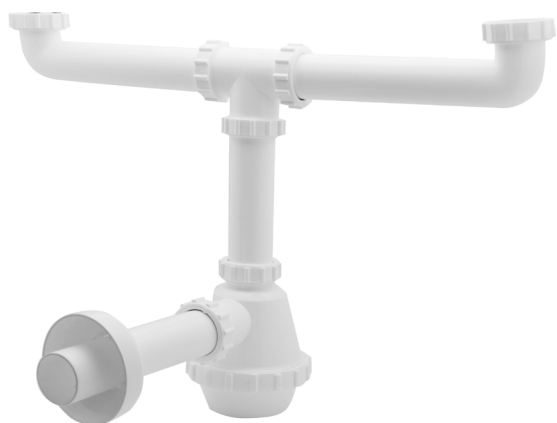
371-323

SIFONE PVC 2 VIE S / PILETTA

Nuovo corpo sifone con scarichi interamente del diametro 40 come da nuove normative europee. Senza scarico lavatrice.

 371-323	 1"1/2 Diam. 40	 20
---	---	--



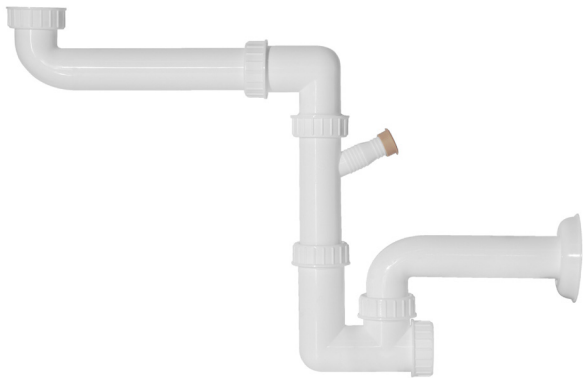

371-3243



SIFONE ISPEZIONABILE SALVASPAZIO 1 VIE

Sifone universale con attacco lavastoviglie. Uscita Diam. 40 mm

 371-3243	 1"1/2	 1
--	--	---





DIANHYDRO

371-3247



SIFONE ISPEZIONABILE SALVASPAZIO 2 VIE 1 ATT.

Sifone ispezionabile Space-saver universale a due vie, Attacco lavastoviglie.

 371-3247	 1"1/2	 1
--	--	---





DIANHYDRO

371-3248



SIFONE AUTOPULENTE SALVASPAZIO PER LAVABO

 371-3248	 1"1/4 x 32	 1
--	---	---



DIANHYDRO



371-M356**SIFONE SALVASPAZIO A 2 VIE CON ATT. LAVASTOVIGLIE**

Sifone autopulente salvaspazio a 2 vie (vasche piane e sfalsate) con doppio attacco lavastoviglie e speciale valvola di aerazione. Interasse 575-605 mm. Uscita DN 40. Entrata G1"1/2.

 371-M356	 1"1/2	 7
--	--	---



**371-M357****SIFONE AUTOPULENTE A 1 VIA CON ATTACCO LAVASTOVIGLIE**

Sifone autopulente. Entrata G1"1/2. Uscita DN40.

 371-M357	 1"1/2	 1
--	--	---

**371-M358****SIFONE AUTOPULENTE SALVASPAZIO A 1 VIA CON DOPPIO ATT. LAVASTOVIGLIE**

Con doppio attacco lavastoviglie e speciale valvola di aerazione. Entrata G1"1/2. Uscita DN40.

 371-M358	 1"1/2	 1
--	--	---



371-M359



SIFONE AUTOPULENTE A 2 VIE E 2 ATTACCHI LAVASTOVIGLIE

Sifone autopulente salvaspazio a 2 vie per vasche piane e sfalsate. Nuova crociera mod. URSA (guarnizioni bi-iniettate) con doppio attacco lavastoviglie e valvolina di aerazione. Lunghezza interasse max 590 mm. Uscita DN 40.



371-M359



Uscita DN40



8



DIANHYDRO

371-M360



SIFONE AUTOPULENTE A 1 VIA SALVASPAZIO CON 2 ATTACCHI LAVASTOVIGLIE

Sifone autopulente a 1 via salvaspazio. Nuovo angolo con guarnizione bi-iniettata con valvolina di aerazione e doppio attacco lavastoviglie. Interasse lunghezza max. 300 mm. Uscita DN 40.



371-M360



Uscita DN40



1



DIANHYDRO

371-M3601



SIFONE A 3 VIE CON DOPPIO ATTACCO LAVASTOVIGLIE

Sifone salvaspazio autopulente a 3 vie (vasche piane a sfalsate) con doppio attacco lavastoviglie e speciale valvola di aerazione. Interasse max 750mm. Entrata G1/2. Uscita DN40.



371-M3601



1 1/2



1





DIANHYDRO

371-M3602**KIT PER LAVATOIO 1 VIA PILETTA D.70**

Piletta Diam. 70 mm tappo maniglia bianco, troppo pieno compatto rotondo inox e sifone ispezionabile con attacco lavatrice. Materia plastica: PP, PVC e gomma. Metalli Acciaio Inox AISI 304.



 371-M3602	 Uscita DN40	 20
---	--	--

**371-M361****ECCENTRICO BICOMPONENTE DN 32-40**

 371-M361	 -	 50
--	--	--

**371-M362****ATTACCO LAVASTOVIGLIE USCITA DN 40**

Attacco lavastoviglie uscita DN 40, guarnizione piatta in gomma Diam. 40 mm, ghiera G1 1/2.

 371-M362	 1"1/2 250 mm	 30
371-M362-130	1"1/2 130 mm	60





371-M363



**DOPPIO ATTACCO LAVASTOVIGLIE USCITA DN
40**

Doppio attacco lavastoviglie uscita DN 40, guarnizione piatta in gomma Diam. 40 mm, ghiera G1"1/2.

 371-M363	 1"1/2 250 mm	 30
--	---	--





DIANHYDRO

371-333



**RIDUZIONE IN PVC PER SIFONI DA PORCELLANA
A INOX**

Per ridurre i sifoni in PVC dalla Porcellana all'Inox, M 1"1/4 - F 1"1/2.

 371-333	 M 1"1/4 x F 1"1/2	 1
---	--	---





DIANHYDRO

371-3331



RIDUZIONE IN PVC PER SIFONI IN MOPLEN

Per ridurre i sifoni in PVC.

 371-3331	 F 1"1/4 x M 1"	 1
--	---	---



DIANHYDRO





371-334**RIDUZIONE IN PVC PER SIFONI DA INOX A PORCELLANA**

Per ridurre i sifoni in PVC dalla Porcellana all'Inox. M 1"1/2 x F 1"1/4

 371-334	 M 1"1/2 x F 1"1/4	 1
---	--	---







**371-3341****RIDUZIONE IN PVC PER SIFONI IN MOPLEN**

Per ridurre i sifoni in PVC.

 371-3341	 F 1" x M 1"1/4	 1
 371-3341-0708	 F 1"1/4 x M 1"1/2	 1

**371-337****ROSONE PVC UNIVERSALE**



Per canotti.

 371-337-32	 Diam. 32	 1
 371-337-40	 Diam. 40	 1



371-3601**KIT SIFONE ESTENSIBILE D. 1"1/4 X 32 + COVER**

Tubo formidabile estensibile per sifoni con ghiera cromata + Cover.

 371-3601-07	 Diam. 1"1/4 x 32	 1
---	---	---

**DIANHYDRO®****371-3602****KIT SIFONE ESTENSIBILE D. 1"1/2 X 40 + COVER**

Tubo formidabile estensibile con ghiera in plastica bianca 1"1/2 e morsetto in gomma D.40 + Cover.

 371-3602-08	 Diam. 1"1/2 x 40	 1
---	---	---

**DIANHYDRO®****371-372****KIT BREVETTATO TUBO E RACCORDI "OTO-REX"**

Kit composto da Nr.1 Tubo dn32, Nr.1 Raccordo 1"1/4, Nr.1 Raccordo 1"1/2, Nr.1 Imbuto dn32, Nr.1 Imbuto dn40. Per la saldatura dei raccordi al tubo basta frizionare il raccordo nel tubo fino a farlo riscaldare, si bloccherà automaticamente.

 371-372	 1"1/4 - 1"1/2 - Diam. 32-40	 50
---	--	--

**DIANHYDRO®**

tubi e raccordi di scarico in plastica

371-M1224



TUBO ESTENSIBILE CON GHIERA IN METALLO

Lunghezza 300-710 mm.

Icona	Modello	Dimensioni	Quantità
	371-M1224-0732	1"1/4 x 32	1
	371-M1224-073240	1"1/4 x 32/40	1
	371-M1224-083240	1"1/2 x 32/40	1
	371-M1224-084050	1"1/2 x 40/50	1



371-M1294

CURVA TECNICA PER WC



Icona	Modello	Dimensioni	Quantità
	371-M1294	Diam. 90	30



371-M1295

CURVA TECNICA



Icona	Modello	Dimensioni	Quantità
	371-M1295	Diam. 100	24



371-M1296

**CURVA SOTTOVASO IN PLASTICA RIGIDA
BIANCA**



Femmina dal diam. 100 mm, Maschio dal diam. 110 mm.

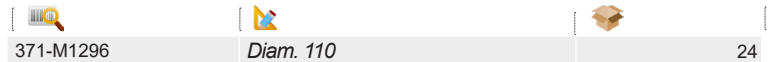

371-M12963

CURVA TECNICA PER WC D.110 + KIT STAFFA

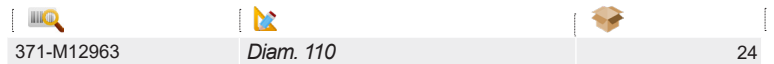

371-M1297

**PROLUNGA PER SCARICO A PARETE CON
BORCHIA**



Prolunga per scarico a parete, per la connessione tra il W.C. e lo scarico a muro in PP, dotata di guarnizione a labbro, lunghezza mm 260.

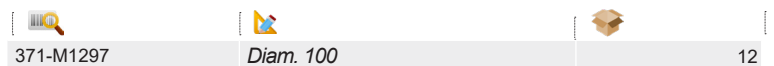

371-M1300



CURVA SOTTOVASO PER RISTRUTTURAZIONI REGOLABILE IN LUNGHEZZA

 371-M1300	 <i>Diam. 100/110</i>	 1
---	---	---

**371-M1301**

PROLUNGA CURVA WC CON GUARNIZIONE DI TENUTA

Curva 90° in PP con guarnizione di tenuta, uscita guarnizione con alette.



 371-M1301	 <i>Diam. 90 - 90/110</i>	 1
---	---	---

**371-M1302**

PROLUNGA WC CORTA MASCHIO CON GUARNIZIONE DI TENUTA

Prolunga rigida corta maschio con guarnizione di tenuta. L: 120 mm / Outlet WC D. 85-107 mm. / Ext 100 mm - Int. 94 mm.





 371-M1302	 -	 1
---	--	---



tubi e raccordi di scarico in plastica**371-M1303****PROLUNGA WC CORTA MASCHIO CON GUARNIZIONE DI TENUTA TROPPO PIENO**

Prolunga rigida corta maschio con guarnizione di tenuta troppo pieno 40 mm.
L: 120 mm / Outlet WC D. 85-107 mm. / Ext 100 mm - Int. 94 mm.

		
371-M1303	-	1





DIANHYDRO®
371-M1304**CURVA TECNICA AD "S" TAGLIABILE A MISURA
DIAM. 100**

Curva per connettere WC carenati allo scarico a pavimento. Puo' essere tagliata fino 100 mm . Canale di uscita D. 100 mm. Solitamente usata nel range 150/230 mm dal muro.

		
371-M1304	Diam. 100 mm	1

DIANHYDRO®
371-M1306**CURVA TECNICA "L" TAGLIABILE A MISURA**



Curva per connettere WC carenati allo scarico a pavimento. Puo' essere tagliata fino 100 mm . Canale di uscita da D. 90 a 110 mm. Solitamente usata nel range 60/140 mm dal muro.

		
371-M1306	D. 90/110	1

DIANHYDRO®

371-M1307**RACCORDO ECCENTRICO PER ADDUZIONE ACQUA**

Utilizzato per connettere il canale di adduzione acqua al WC. Con 10 mm di eccentricità. Lungh. 100 mm

 371-M1307	 D. 40/45	 1
---	---	---

**DIANHYDRO®****371-1116****TAPPO PER TROPPO PIENO UNIVERSALE**

Tappo per troppo pieno Cromato.

 371-1116	 Diam 19 a Diam.28	 25
--	--	--

**DIANHYDRO®****371-11160****GHIERA DI RICAMBIO PER TROPPO PIENO ABS CROMATO**

 371-11160-19	 Diam. 19	 25
371-11160-24	Diam. 24	25
371-11160-28	Diam. 28	25

**DIANHYDRO®**

pilette in plastica per doccia, lavelli, cestelli e griglie pilette

371-11161**BORCHIA COPRIFORO IN ABS CROMATO**

Parte esterna Diam. 35 mm.

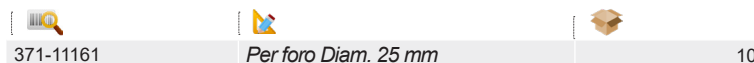
**371-11162****GHIERA GETTO PARABOLICO IN ABS PER FORO VASO-BIDET**

Per foro uscita acqua del bidet. Il getto è di materiale plastico ABS. Il getto è alto in totale 16 mm e per 13 mm entra nel foro bidet. Il diametro alettato è di 14 mm.

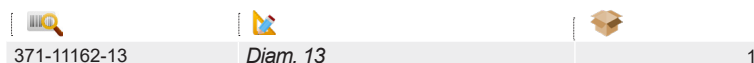
**371-11163****GHIERA OVALE BOMBATA PER TROPPO PIENO IN ABS**

Per foro troppo pieno del lavabo con un asola 38x11 mm. La ghiera è di materiale plastico ABS.

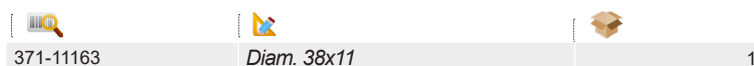



371-330**PILETTONE PER LAVELLO INOX**

Piletta STP, diam. 70 con tappo maniglia.

 371-330	 1"1/2	 1
---	--	---







**371-331****PILETTA PER LAVELLO INOX CON TROPPO PIENO**

Piletta CTP, diam. 70 con tappo maniglia di fissaggio e con tubo collegamento rigido.

 371-331	 1"1/2	 80
---	--	--

**371-332****PILETTA PER LAVELLO PORCELLANA**

Piletta gattinara PP, diam. 80 tappo maniglia.



 371-332	 1"1/4	 10
 371-332-08	 1"1/2	 10





pilette in plastica per doccia, lavelli, cestelli e griglie pilette

371-3321**PILETTA SIMPLEX CON TAPPO MANIGLIA**

Per lavabi.



 371-3321	 1" 1/4 x Diam. 65	 1
--	--	---

**371-3911****PIATTELLO DI RICAMBIO PER PILETTA 371-391**

 371-3911-090	 Diam. 90	 1
--	---	---

**371-395****PILETTA SIFONATA PER PIATTI DOCCIA RIBASSATI SIMIL-STONE**

Piletta ribassata diametro 90 mm, per piatti doccia "Simil Stone" - Nostro Articolo 179-SDB-... e 179-SDN-... In PVC.

 371-395	 Diam. 90	 1
---	---	---



pilette in plastica per doccia, lavelli, cestelli e griglie pilette

371-3950
**PIATTELO DI RICAMBIO PER PILETTA ART 371-395
395 SIMIL-STONE**

	371-3950	Cromo - Diam. 12 cm	1
	371-3950-BI	Bianco - Diam. 12 cm	1

**371-3952**
**PILETTA SIFONATA LUX RIBASSATA 3 VITI UNIV.
PER PIATTI DOCCIA STONE**

Piletta ribassata per piatti doccia stone, senza cover.

	371-3952	Diam. 90	1
--	----------	----------	---

**371-3953**
**PILETTA DRAIN MASTER DH PER PIATTO
DOCCIA**

Piletta sifonata per piatti doccia ribassati, con anello di fissaggio in acciaio Inox. Sifone di diametro 40 mm, portata di 52 L/min. Altezza minima di installazione 57 mm. Conforme allo standard EN 274-1:2002. Compatibile con nostri piatti doccia Serenity, Estasi, Bliss.



	371-3953	Diam. 90	1
--	----------	----------	---



pilette in plastica per doccia, lavelli, cestelli e griglie pilette

371-3954**PIATTELLO PER PILETTA DRAIN MASTER**

Piattello di ricambio in ABS cromato per le nostre pilette Drain Master PRO 371-M3112 .

 371-3954	 <i>Cromo</i>	 1
--	---	---



371-3955**KIT INSTALLAZIONE PIATTELLO PER PILETTA DRAIN MASTER**

Kit installazione composto da 3 viti e dal piattello in ABS cromato per le nostre pilette Drain Master 371-3953.

 371-3955	 -	 1
--	--	---



371-3961**GRIGLIA PER PIATTI DOCCIA SERENITY**



In acciaio Inox. Per piatti doccia "Serenity" - Nostri Articoli 179-MSA-... / 179-MSQ-.../ 179-MSR-... Dimensioni: cm 12,5 x 12,5

 371-3961	 <i>Inox</i>	 1
371-3961-B	<i>Bianco</i>	1
371-3961-C	<i>Beige</i>	1
371-3961-G	<i>Grigio</i>	1
371-3961-N	<i>Nero</i>	1





371-3962**GRIGLIA PER PIATTI DOCCIA ESTASI**

In acciaio inox. Per piatti doccia "Estasi" Codici 179-LEQ- e 179-LER-

 371-3962	 <i>Inox</i>	 1
--	--	---

**371-397****PILETTA SIFONATA PER PIATTO DOCCIA STONE ESSENCE**

Piletta per piatti doccia Stone Essence Art. 179-SM... e Serenity 179-MS...

 371-397	 <i>Diam. 90</i>	 50
---	--	--

**371-3971****PILETTA PER PIATTI DOCCIA EUPHORIA**

Piletta dedicata ai piatti doccia Euphoria cod. 179-ME... Altezza piletta 86 mm, portata di 49 L/min, materiale PP.

 371-3971	 <i>221 x 96,75 mm</i>	 1
--	--	---



pilette in plastica per doccia, lavelli, cestelli e griglie pilette

371-398**PILETTA SIFONATA PER PIATTI DOCCIA SIFONE ESTRAIBILE**

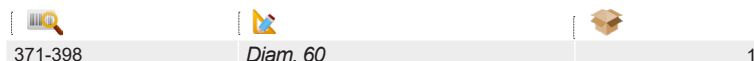
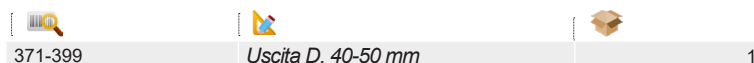
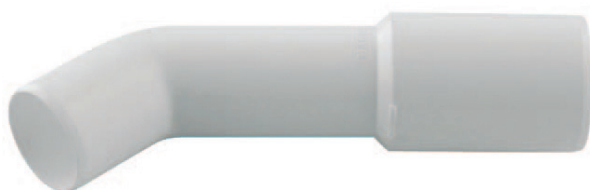

Piletta di scarico 1"1/2 con sifone estraibile per piatto doccia con foro Diam. 60 mm.

371-399**RACCORDO CURVO 45° IN POLIPROPILENE**
371-3992**PILETTA SIFONATA PER PIATTO DOCCIA D. 90**



Sifone in ABS cromo D.90 per piatto doccia. Il sifone è composto da materiale plastico: ABS e Gomma. Può essere installato su tutti i piatti doccia e piatti doccia disabili. La finitura del coperchio è cromo. Il sifone è denominato 90 per il foro del piattodoccia. Il sifone piattodoccia è alto 60mm con diametro totale di 135mm e il tubo di uscita di 40 mm. Il coperchio è cromato e di diametro 115mm.





371-H122**CESTELLO COMPLETO DI PERNO E POMOLO**

		
371-H122-83	Diam. 83	1
371-H122-83R	Diam. 83 ribassata	1

**371-M2001****GRIGLIA INOX PER PILETTA LAVELLO**

		
371-M2001	-	50

**371-M2002****GRIGLIA INOX PER PILETTA LAVELLO "STOPPER"**

		
371-M2002	Diam. 80	50
371-M2002-070	Diam. 70	50



pilette in plastica per doccia, lavelli, cestelli e griglie pilette

371-M2003

**GRIGLIA DIAM. 9 CM PER FORO LAVELLO DIAM.
4.5 CM**

In PP.



371-M2003-BI	Bianca	12
371-M2003-CR	Cromo	12

**371-M3090**

PILETTA BASKET CROMATA

Piletta per lavello dal diam. 90 mm (entrata 3"1/2) senza troppo pieno, con cestello e gattinara in acciaio inox, scarico filettato da 1"1/2. Vite Lungh. 7 cm.

371-M3090	1" 1/2	5

**371-M3091**

PILETTA BASKET CON TROPPO PIENO

Piletta per lavello dal diam. 90 mm (entrata 3"1/2) con troppo pieno, con cestello e gattinara in acciaio inox, scarico filettato da 1"1/2.

371-M3091	1" 1/2	5





pilette in plastica per doccia, lavelli, cestelli e griglie pilette

371-M30912



**PILETTA BASKET CLASSIC CON TROPPO PIENO
TONDO**

Piletta D.114 con tappo cestello per lavello con foro D.90 con tp rigido snodato
rotondo - classic.



 371-M30912	 1" 1/2	 5
--	---	---



371-M30913

**10 PZ GUARNIZIONI IN GOMMA PER PILETTA
D.114**



 371-M30913	 D. 114 mm	 1
--	--	---





371-M3092



PILETTA CON TUBO INOX 250 MM

Piletta diametro 70



 371-M3092	 -	 1
---	--	---



pilette in plastica per doccia, lavelli, cestelli e griglie pilette



371-M3093**TAPPO CESTELLO DM 83 MOD. MUX PER PILETTA**

Per piletta 3" 1/2.

 371-M3093	 Diam. 83	 1
---	---	---

**371-M3094****TAPPO CESTELLINO INOX DM 52 MOD. LUX PER PILETTA**

Per piletta Diam. 70

 371-M3094	 -	 1
---	--	---

**371-M3095****VITE DISTANZIALE PER PILETTA BASKET M3090**

Specifico per ns articolo 371-M3090

 371-M3095	 M12 x 70	 1
 371-M3095-1236	 M12 x 36 Ottone nichelato	 1
 371-M3095-1246	 M12 x 46	 1





pilette in plastica per doccia, lavelli, cestelli e griglie pilette

371-M3098

**TAPPO CESTELLO DM 79 MOD. MULTI RAY LUX
PER PILETTA**



Per piletta Diam. 114

 371-M3098	 -	 1
---	--	---



371-M3099

TROPPO PIENO PER LAVABO CON 2 GUARN.



Tropo pieno itercalare.

 371-M3099	 1"1/4 x D.63	 1
---	---	---





371-M3100

PILETTA 114 MM TAPPO CESTELLO QUADRATO



Piletta D. 114 mm per lavello con foro D. 90 mm. Tappo cestello quadrato. Applicazione: inox e sintetici. Materiale: PP, PVC e gomma. Metalli Acciaio inox AISI 304, ottone nichelato.



 371-M3100	 1"1/2	 1
---	--	---



pilette in plastica per doccia, lavelli, cestelli e griglie pilette



371-M3101**PILETTA 114 MM TAPPO CESTELLO QUADRATO
CT**

Piletta D. 114 mm per lavello con foro D. 90 mm. Tappo cestello quadrato con troppo pieno compattabile rettangolare. Applicazione Inox. Materiali: PP, PVC e gomma. Metalli: Acciaio inox AISI 304, ottone nichelato.

 371-M3101	 1"1/2	 1
---	--	---



**371-M3102****PILETTA 114 MM SENZA TROPPO PIENO**

Piletta D. 114 mm per lavello con foro D. 90 mm, tappo cestello. Applicazioni inox, sintetici e ceramica. Materiale plastica PP, PVC e gomma, acciaio inox Aisi 304, ottone nichelato.

 371-M3102	 1"1/2	 1
---	--	---

**371-M3103****PILETTA 114 MM TAPPO CESTELLO PER LAVELLI
MARMO E PIETRA**

Piletta D. 114 mm per lavello con foro da D. 90 mm, senza troppo pieno. Tappo cestello applicazioni: inox, sintetici, pietra e ceramica. Materiali PP, PVC e gomma, acciaio inox AISI 304, ottone nichelato.

 371-M3103	 1"1/2	 1
---	--	---





pilette in plastica per doccia, lavelli, cestelli e griglie pilette

371-M31032**PILETTA 114 MM PER LAVELLO CON FORO 90 MM**

Piletta Diam. 114 mm tappo cestello modello Mineral. Applicazione: Inox, sintetici, ceramica e pietra. Materia plastica: PP, PVC e gomma. Metalli: Acciaio Inox AISI 304, ottone nichelato.



		
371-M31032-CO	Copper - Rame anticato	1
371-M31032-PI	Pirite - Ottone anticato	1



**371-M3104****PILETTA D. 114 MM TROPPO PIENO RETTANGOLARE**

Piletta D. 114 mm per lavello con foro D. 90 mm, tappo cestello con troppo pieno rettangolare snodato. Applicazione: Inox, sintetici e ceramica. Materiali: PP, PVC, gomma, acciaio inox AISI 304, ottone nichelato.

		
371-M3104	1"1/2	1

**371-M3105****PILETTA D.114 TROPPO PIENO ROTONDO**

Piletta D. 114 mm per lavello con foro D. 90 mm, tappo cestello con troppo pieno rotondo snodato con piastrina inox smart. Applicazione: inox, sintetici e ceramica. Materia plastica PP, PVC e gomma, acciaio inox AISI 304, ottone nichelato.



		
371-M3105	1"1/2	1



pilette in plastica per doccia, lavelli, cestelli e griglie pilette



371-M3106**PILETTA 114 MM PER LAVELLO CON FORO 90 MM COLOR**

Piletta Diam. 114 mm, per lavelli con spessore da 7 a 11 mm. Modello Color in plastica con troppo pieno estensibile rotondo. Applicazione: inox, sintetici e ceramica. Materia plastica: PP, PVC e gomma. Metalli: ottone nichelato.

		
371-M3106-BI	Bianco	1
371-M3106-NE	Nero	1

**371-M3107****PILETTA 114 MM TROPPO PIENO RETTANGOLARE**

Piletta Diam. 114 mm tappo cestello con troppo pieno estensibile rettangolare per sgocciolatoio. Applicazione: Inox. Materia plastica: PP, PVC e gomma. Metalli: Acciaio Inox AISI 304.

		
371-M3107	1"1/2	1



**371-M3108****PILETTA 114 MM TROPPO PIENO ROTONDO**

Piletta Diam. 114 mm tappo cestello con troppo pieno estensibile rotondo. Applicazione: Inox, sintetici e ceramica. Materia plastica: PP, PVC e gomma. Metalli: Acciaio Inox AISI 304.

		
371-M3108	1"1/2	1



371-M3109**PILETTA D.114 CLASSIC CON TROPPO PIENO
RETTANGOLARE**

 371-M3109	 -	 1
---	--	---

**371-M3110****PILETTA SIFONATA PER PIATTI DOCCIA**



Piletta per piatto doccia foro D. 90 mm. Piastra decorativa D. 120 mm. Materia Plastica PP, PVC e gomma. Acciaio Inox Aisi 304.

 371-M3110	 <i>Diam. 90</i>	 1
371-M3110-060	<i>Diam. Int 60</i>	1

**371-M3112****PILETTA DRAIN MASTER PRO PER PIATTO
DOCCIA**

Piletta sifonata per piatti doccia ribassati. Sifone di diametro 40 mm, portata di 52 L/min. Altezza minima di installazione 57 mm. Conforme allo standard EN 274-1:2002. Compatibile con piatti doccia Simil-Stone nostri articoli 179-SDN/179-SDB. La piletta è composta dalla base in PP e dal kit di installazione del piattello: anello di fissaggio in PP, viti in acciaio inox e piattello in ABS cromato.



 371-M3112	 <i>Diam. 90</i>	 1
---	--	---



pilette in plastica per doccia, lavelli, cestelli e griglie pilette

371-P1371**CANALINA PER PIATTI DOCCIA ARTU'**

Canalina per doccia filo pavimento, con griglia e cornice in acciaio inox. Griglia reversibile e personalizzabile. Altezza minima installazione 52 mm.



Model	Height	Quantity
371-P1371-300	mm 300	1
371-P1371-450	mm 450	1
371-P1371-550	mm 550	1
371-P1371-650	mm 650	1
371-P1371-750	mm 750	1
371-P1371-850	mm 850	1
371-P1371-950	mm 950	1

**371-P1372****CANALINA DOCCIA MERLINO**

Canalina per doccia filo pavimento, con griglia in acciaio inox, reversibile e personalizzabile. Senza cornice. Altezza minima installazione 62 mm.

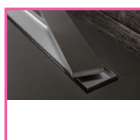

Model	Height	Quantity
371-P1372-300	mm 300	1
371-P1372-450	mm 450	1
371-P1372-550	mm 550	1
371-P1372-650	mm 650	1
371-P1372-750	mm 750	1
371-P1372-850	mm 850	1
371-P1372-950	mm 950	1

**371-P1373****CANALINA DOCCIA MORGANA**

Canalina per doccia filo pavimento, con griglia in acciaio inox, ultra sottile (4 mm). Altezza minima installazione 72 mm.

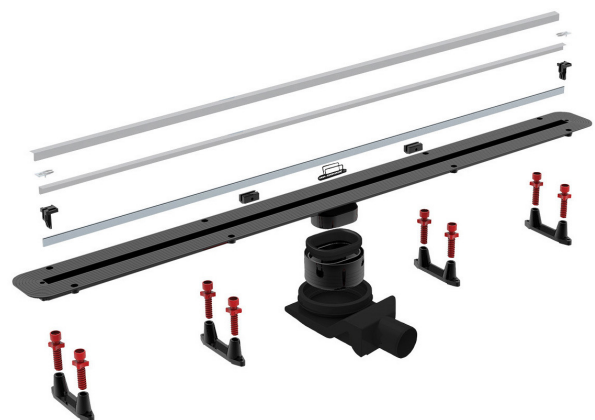

Model	Height	Quantity
371-P1373-550	mm 550	1
371-P1373-650	mm 650	1
371-P1373-750	mm 750	1
371-P1373-850	mm 850	1



371-P1374**CANALINA DOCCIA GINEVRA**

Canalina per doccia filo pavimento, con griglia in acciaio inox, reversibile e personalizzabile. Senza cornice. Altezza minima installazione 52 mm.

Icona	Modello	Dimensione	Quantità
	371-P1374-450	mm 450	1
	371-P1374-550	mm 550	1
	371-P1374-650	mm 650	1
	371-P1374-750	mm 750	1
	371-P1374-850	mm 850	1

**DIANHYDRO****371-P1375****CANALINA DOCCIA LANCILLOTTO**

Canalina per doccia filo pavimento, con griglia e cornice in acciaio inox. Griglia reversibile e personalizzabile. Altezza minima installazione 52 mm.

Icona	Modello	Dimensione	Quantità
	371-P1375-450	mm 450	1
	371-P1375-550	mm 550	1
	371-P1375-650	mm 650	1
	371-P1375-750	mm 750	1
	371-P1375-850	mm 850	1

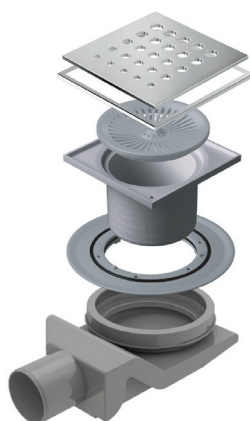
**DIANHYDRO****371-P1801****CANALINA SCARICO DOCCIA QUADRATA GOCCIA**

Canalina quadrata per doccia filo pavimento, con griglia e cornice in acciaio inox. Altezza minima installazione 56 mm.



Icona	Modello	Dimensione	Quantità
	371-P1801-15	15x15	1

**DIANHYDRO**

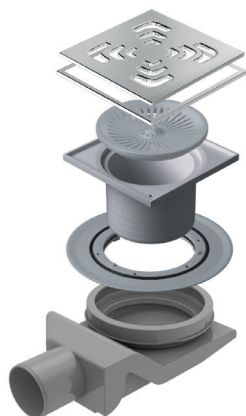
pilette in plastica per doccia, lavelli, cestelli e griglie pilette



371-P1802**CANALINA SCARICO DOCCIA QUADRATA ANGOLO**

Canalina quadrata per doccia filo pavimento, con griglia e cornice in acciaio inox. Altezza minima installazione 56 mm.

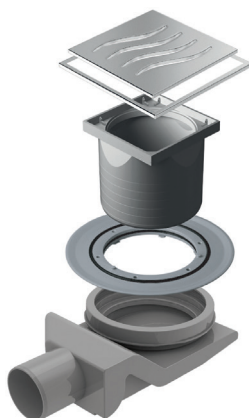
 371-P1802-15	 15x15	 1
--	--	---







**371-P1803****CANALINA SCARICO DOCCIA QUADRATA ONDA**

Canalina quadrata per doccia filo pavimento, con griglia e cornice in acciaio inox. Altezza minima installazione 56 mm.

 371-P1803-10	 10x10	 1
--	--	---

**371-P1804****CANALINA SCARICO DOCCIA QUADRATA STANDARD**

Canalina per doccia filo pavimento, con griglia e cornice in acciaio inox. Griglia reversibile e personalizzabile. Altezza minima installazione 56 mm.



 371-P1804-10	 10x10	 1
 371-P1804-15	 15x15	 1

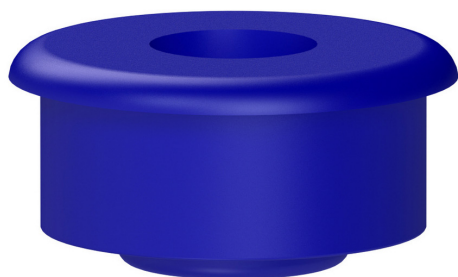

372-4012



TAPPINO BLU PER ATTACCO LAVASTOVIGLIE

 372-4012	 -	 1
--	--	---





DIANHYDRO

372-4013

ATTACCHINO 90° DN 40



 372-4013	 <i>D. 20-24 mm</i>	 1
--	--	---





DIANHYDRO

372-4014

ATTACCHINO DRITTO DN 40







 372-4014	 <i>D. 20-24 mm</i>	 1
--	---	---



DIANHYDRO

372-4015**CANOTTO CON 2 ATTACCHI PER LAVATRICE
LAVASTOVIGLIE**

 372-4015-08	 1"1/2	 1"1/4-1"1/2	 1
---	--	---	---



DIANHYDRO®

372-402**RACCORDO PER ATTACCO LAVATRICE CON
GHIERA E GUARNIZIONE**

Raccordo in plastica.

 372-402	 1" Bianca	 500
---	--	---





DIANHYDRO®

372-4031**CANOTTO CROMATO PER SCARICO LAVATRICE**

Completo di curva.



 372-4031-2625	 Diam.26 x 250 mm	 1
372-4031-2630	Diam.26 x 300 mm	1
372-4031-3025	Diam.30 x 250 mm	1
372-4031-3030	Diam.30 x 300 mm	1
372-4031-3225	Diam.32 x 250 mm	1
372-4031-3230	Diam.32 x 300 mm	1
372-4031-4025	Diam.40 x 250 mm	1



DIANHYDRO®

raccordi per lavatrice

372-404**GIUNTO PER TUBO SCARICO LAVATRICE**

Raccordo in plastica.

		
372-404-1717	Diam. 17 x 17	1
372-404-1722	Diam. 17 x 22	1
372-404-2222	Diam. 22 x 22	1



**372-405****NIPPLE DOPPIO FILETTO MASCHIO**

Raccordi in plastica.

		
372-405	Diam. 3/4 x 3/4	1

**372-406****RACCORDO Y PER LAVATRICE**

Raccordo in plastica.

		
372-406	Diam. 3/4F. x 3/4 M. x 3/4M.	1



372-339**TUBO CARICO LAVATRICE FF**

Fornito senza guarnizioni (nostro articolo 200-248).

372-339-10	FF 3/4" x 100 cm		25
372-339-15	FF 3/4" x 150 cm		25
372-339-20	FF 3/4" x 200 cm		25
372-339-25	FF 3/4" x 250 cm		25
372-339-30	FF 3/4" x 300 cm		25

**372-3391****TUBO CARICO LAVATRICE MF**

Tubo carico millerighe 10x14. Raccordi nylon con guarnizioni.



372-3391-10	MF 3/4" x 100 cm		25
372-3391-15	MF 3/4" x 150 cm		25
372-3391-20	MF 3/4" x 200 cm		25
372-3391-25	MF 3/4" x 250 cm		25
372-3391-30	MF 3/4" x 300 cm		25

**372-440****TUBO CARICO LAVATRICE CON CURVA**

Fornito senza guarnizioni (nostro articolo 200-248).



372-440-15	mt. 1,50		25
372-440-20	mt. 2,00		25
372-440-25	mt. 2,50		25
372-440-30	mt. 3,00		25



tubi per lavatrice



372-441**TUBO SCARICO LAVATRICE UNIVERSALE**

Tubo di scarico lavatrice flessibile corrugato. Raccordi integrati. Adattabile a tutte le posizioni di attacco. Unico prodotto per tutte le lavatrici e lavastoviglie in commercio.

		
372-441-15	mt. 1,50	50
372-441-20	mt. 2,00	50
372-441-25	mt. 2,50	50



**372-442****SUPPORTO PER TUBO DI SCARICO LAVATRICE**

Da utilizzare con il tubo scarico lavatrice, nostro articolo 372-441.

		
372-442	-	100

**372-444****TUBO CARICO LAVATRICE INOX CON CURVA**

Tubo carico lavatrice realizzato con flessibile inox, completo di raccordi e curva

		
372-444-20	mt. 2,00	25
372-444-30	mt 3	25



**TUBO CARICO LAVATAZZE - LAVABICCHIERI -
LAVATRICE CON CURVA**



Tubo di carico PVC DN 10 per lavatazze e lavabicchieri - 10 x 16 Grigio banda rossa. 10 bar 90° - Ghiera Nylon.



372-446-15



F FC 3/4" 150 cm



50



DIANHYDRO